

Method Statement

Waterproofing potable water tanks with KÖSTER TPO Aqua



// Table of Contents

1	General information	4
1.1	Scope	4
1.2	Manufacturer	4
1.3	Definitions	4
2	System Description	5
2.1	System features	5
2.1.1	Characteristics/Advantages	5
2.2	Main products and components	5
2.3	Associated products	5
2.4	Associated literature	5
3	Tools and equipment	6
3.1	Tools	6
3.2	Equipment	6
3.3	Cleaning	6
4	Environmental, health and safety	7
4.1	Personal Protection Equipment (PPE)	7
4.2	Material safety & First Aid	8
4.3	Waste disposal	8
5	Substrate preparation	9
5.1	Project site conditions	9
5.1.1	Application temperature	9
5.1.2	Moisture content in the substrate	9
5.2	Requirements	9
5.3	Preparation	9
5.3.1	Leveling & repairing the surface	10
5.3.2	Rounding edges	10
6	Application/Installation instructions	11
6.1	Installation method	11
6.1.1	Vertical installation	12
6.1.2	Horizontal installation	13
6.2	Seam welding	14
6.2.1	Welding	14

// Table of Contents

6.2.2	Overlaps and joints	15
6.3	Vertical and horizontal connections	16
6.3.1	Vertical connections	16
6.3.2	Horizontal connections	16
6.4	Pipe and other penetrations	16
6.4.1	Rounded pipe penetrations	16
6.4.2	Fixed metallic flanges	17
6.5	Quality control	17
7	Transport and storage	18
8	General notes	18
9	Certifications	18
10	Appendix	19
11	Legal disclaimer	19

1 General information

1.1 Scope

This method statement is intended for use by developers, contractors, and applicators as a general guideline for waterproofing potable water tanks using KÖSTER TPO Aqua waterproofing membranes.

While this document describes the tools, equipment, materials, and step-by-step process for preparing and installing the waterproofing membrane system, it must be used and referred to, in combination with all other relevant technical information available for the material and its components.

1.2 Manufacturer

KÖSTER BAUCHEMIE AG

Dieselstraße 1-10 Tel. 04941/9709-0

D-26607 Aurich Fax 04941/9709-40

info@koester.eu

www.koester.eu 



KÖSTER
Waterproofing Systems

1.3 Definitions

TPO/FPO

TPO is acronymous for Thermoplastic Polyolefin (FPO = Flexible Polyolefin) and it is a type of polymer single-ply membrane that uses thermo-welding (hot air) to connect the seams.

Positive Side Waterproofing

Positive side waterproofing means that the waterproofing layer is applied to the side of the construction member which is in direct contact with water.

Negative Side Waterproofing

Negative side waterproofing means that the waterproofing layer is applied to the side of the construction member which is opposite to the side with direct contact with the water.

Construction Joints

Concrete structures are subjected to a variety of stresses. These stresses are the result of shrinkage and differential movement. Stresses in concrete can be controlled by the proper placement of joints in the structure.

Fillet

A concave easing of an interior corner. By employing fillets on points and lines of expected high stress, stress concentrations are reduced.

2 System description

2.1 System features

KÖSTER TPO Aqua is a specially formulated homogeneous waterproofing membrane for drinking water tanks. KÖSTER TPO Aqua complies with the hygienic requirements for potable water environments according to the

German DVGW Worksheet W 270. The KÖSTER TPO-PE-based membrane is highly tear-resistant and provides very high flexibility so that even large cracks are securely bridged.

2.1.1 Characteristics/Advantages

- Eco-friendly system
- Compatible with any type of substrate
- Recyclable
- Free of plasticizers & VOC
- Weldable indoors – no toxic fumes
- No need for wall-floor round fillets
- For new structures or rehabilitation of old structures
- compatible with any existing coatings or old membranes
- No substrate preparation is needed (see details in section 5)

2.2 Main products and components



KÖSTER TPO Aqua

KÖSTER TPO Aqua is a homogenous thermoplastic polyolefin waterproofing membrane for drinking water structures.

[See online](#)

2.3 Associated products



KÖSTER Bar for membrane fastening

[See online](#)



KÖSTER TPO Metal Composite Sheet light grey

[See online](#)

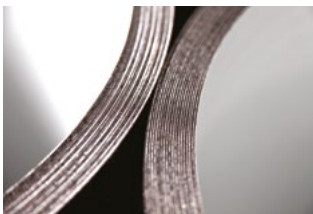

KÖSTER TPO Metal Composite Coil light grey





[See online](#)



KÖSTER Wall connection profile 60 mm

[See online](#)

2.4 Associated literature

- [Technical Data Sheet](#) 
- [KÖSTER TPO Installation Instruction](#) 
- [KÖSTER TPO Accessory Range](#) 
- [Brochure: KÖSTER TPO Aqua](#) 
- [Product Declaration of Performance TPO Aqua 1.5 \(German\)](#) 
- [Certificate of conformity of the factory production control 0761-CPR-0423 MPA Braunschweig](#) 

3 Tools and Equipment

3.1 Tools

Besides general construction working tools, the following specific tools are required:



Measuring tool



Seam tester



Scissors



Kehlfix cornering tool



Knife



Wire brush



KÖSTER Hand pressure roller 40 mm wide



90° angle pressure roller

3.2 Equipment



Hand welder with wide slot Nozzle 40 mm wide



Automatic welding machines



Satin grinding machine

3.3 Cleaning

Before and after the installation of the membranes, all welding nozzles must be mechanically cleaned with a wire brush.

4 Environmental, health and safety

4.1 Personal Protection Equipment (PPE)

The following is a short overview of Personal Protective Equipment and serves only as a guideline. Contractors and Employers are responsible for meeting the occu-

pational safety guidelines in their countries, states, and localities.



Eye protection

Employers must be sure that their employees wear appropriate eye and face protection and that the selected form of protection is appropriate to the work being performed and properly fits each worker exposed to the hazard.

Head protection

Employers must ensure that their employees wear head protection if any of the following apply: Objects might fall from above and strike them on the head; they might bump their heads against fixed objects, such as exposed pipes or beams; or there is a possibility of accidental head contact with electrical hazards.

Foot and Leg Protection

Employees who face possible foot or leg injuries from falling or rolling objects or from crushing or penetrating materials should wear protective footwear.

Hand Protection

When selecting gloves to protect against exposure hazards, always check with the manufacturer or review the manufacturer's product literature to determine the gloves' effectiveness against specific workplace chemicals and conditions. Gloves commonly used are: Coated fabric gloves and Chemical - and Liquid - Resistant Gloves

Hearing protection

Suitable hearing protection must be provided for the job environment.

4.2 Material safety & First Aid

Every KÖSTER product is labeled with specific information and symbols as to the related dangers. Please consult the respective Material Safety Data Sheet for specifics.

After inhalation:

Not applicable.

After contact with skin:

No special measures are necessary.

After contact with eyes:

Not applicable.

After Ingestion:

Not applicable.

Treat symptomatically when Indication of any immediate medical attention and special treatment needed.

4.3 Waste disposal

Disposal recommendations:

Dispose of waste according to applicable legislation.

Contaminated packaging:

Completely emptied packages can be recycled.

5 Substrate preparation

5.1 Project site conditions

5.1.1 Application temperature

The KÖSTER TPO Aqua membranes can be securely welded down to 0 °C air temperature. No upper working temperature has been specified, therefore, adjustments of the welding temperature, are required according to the existing conditions. If changing conditions occur, new adjustments might be required.

5.1.2 Moisture content in the substrate

The substrate can be dry or moist. In case of active leakages, a negative side waterproofing is required before the KÖSTER TPO Aqua installation (please check the KÖSTER negative side waterproofing systems for more details).

5.2 Requirements

Substrates compatible with the KÖSTER TPO Aqua include concrete, mortars, screeds, bricks, masonry, metal, plastic, wood, or almost any other type of material structure.

KÖSTER TPO Aqua is also compatible for direct contact with most cementitious, resin base coatings and membranes without the installation of separation layers,

making the KÖSTER TPO Aqua system the fastest and simplest system for drinking water tank installations. For direct contact with existing bitumen and PVC membranes, it is advisable the installation of a separation layer with a geotextile fleece. For further details please contact our technical department or adhere to the product technical guidelines.



Wide range of substrate compatibility

5.3 Preparation

In general, no major substrate preparation is needed for this system. The substrate must be as smooth as possible and free of edges, depressions, and other defects that can mechanically damage the membrane.

5.3.1 Leveling & repairing the surface

In the case of honeycombed areas, cavities, recesses, and chipped-out areas, as well as all holes or irregularities deeper than 10 mm, these should be filled flush to reduce the risk of puncture. Remove any sharp edges and objects that could also puncture the membrane. For

extra mechanical protection of the membrane on extremely rough substrates, the installation of a geotextile mat (approx. 500 g/m²) on the bottom of the reservoir is recommended before installing the KÖSTER TPO Aqua membrane.



Big gaps and substrate big depressions



Protuberances or sharp edges



Rough bottom substrate



Geotextile

5.3.2 Rounding edges

All sharp corners and edges are to be rounded to a radius of approximately 4 cm.

6 Application/Installation instructions

6.1 Installation method

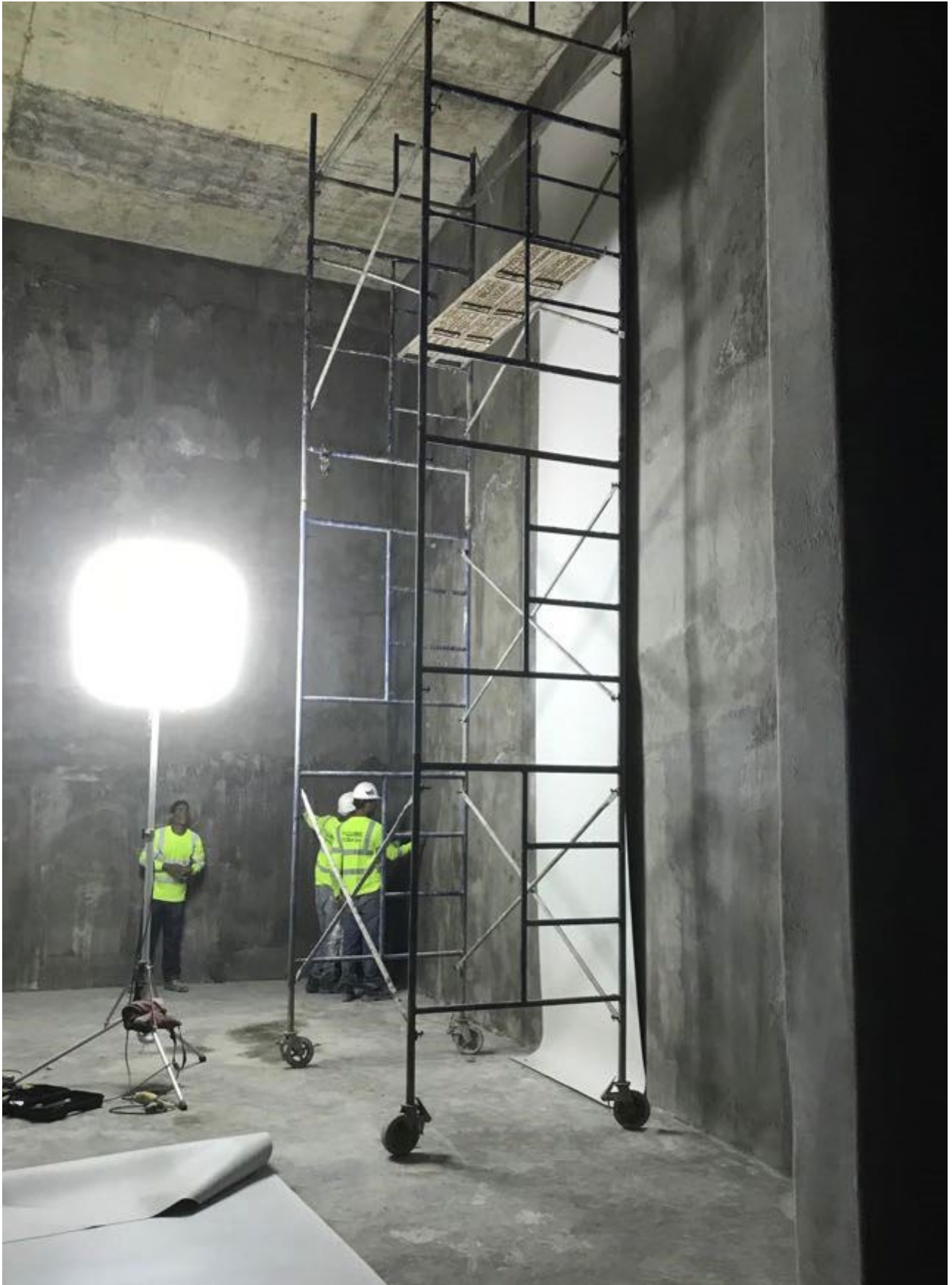

The KÖSTER TPO Aqua waterproofing membranes can be **vertically** or **horizontally** installed without altering the effectiveness of the system. The direction of the

membranes should be chosen considering the water tank conditions such as height, size, access, workability on-site, and ease of installation.

6.1.1 Vertical installation

When installing the KÖSTER TPO Aqua membrane vertically on the walls of the tank, the membranes are mechanically fastened using the KÖSTER Wall connection profile 60 mm to securely fix the membrane at its top edge. Generally, it must be fastened with self-sealing

screws at intervals of 20 cm. The upper part of the profile should turn back to the wall, capping the membrane, and should be caulked with a high-performance mastic sealant such as KÖSTER PU-Flex 25. Any sealant used for this purpose should be subject to regular maintenance.



Alternatively, the top section fixing method can be done using the KÖSTER TPO Metal Composite Sheets. For the installation, cut 16 cm wide stripes of KÖSTER TPO Metal Composite Sheets. Put a line of KÖSTER PU-Flex 25 on the location where the metal sheet will be fastened, and fasten the metal stripes directly to the substrate with

proper screws and washers at a maximum distance of 20 cm between fasteners. The PU joint sealant should be squeezed behind the metal stripe for sealing the potential water penetration behind the membrane. Weld the membrane directly to the KÖSTER TPO Metal Composite Sheets covering at least 6 cm of the metal area.



Attention: Regardless of the chosen installation method, the upper mechanical fastening must be placed at least 15 cm above the maximum water level of the tank.

On walls up to 2,5 meters high, no fastening method is required since the weight of the water holds the membrane against the walls. For the tank bottom area, mechanical fastening is also not required for the same reasons, except in particular cases.

After the KÖSTER TPO Aqua membranes are mechanically fastened at the top, the rolls are vertically hung loose for welding the overlapping. Depending on the height of the tank, intermediate fastenings are needed for keeping the membrane in place, better shaping, and avoiding creases. For details on intermediate fastening see table below.

Wall height	Distance between intermediate fastenings
Up to 2.5 m	No fastening needed
2.5 m to 5.0 m	Every 40 - 50 cm
Over 5.0 m	Every 20 - 25 cm



6.1.2 Horizontal installation

The KÖSTER TPO Aqua membranes can also be installed horizontally. This installation method is especially suitable for low-height water tanks.

The membranes are horizontally unrolled and mechanically fastened at the same time. All rolls must be

mechanically fixed along the perimeter of the tank, with mechanical fixations every 30 cm. During the installation, the placing of the membrane on the walls should always be done from the bottom to the top. The first roll is laid on the bottom section of the wall and sequentially rising, leaving at least 11 cm overlapping for the welding.



When installing the KÖSTER TPO Aqua membrane horizontally on the walls of the tank, the membranes are mechanically fastened using the KÖSTER Wall connection profile 60 mm to securely fix the membrane at its top edge. Generally, it must be fastened with self-sealing screws at intervals of 20 cm. The upper part of the profile should turn back to the wall, capping the membrane, and should be caulked with a high-performance mastic sealant such as KÖSTER PU-Flex 25. Any sealant used for this purpose should be subject to regular maintenance.

Alternatively, the KÖSTER TPO Metal Composite Sheets can be used to fix the membrane at its top edge. For the installation, cut 20 cm wide stripes of KÖSTER TPO Metal Composite Sheets. Put a line of KÖSTER PU-Flex 25 on

the location where the metal sheet will be fastened, and fasten the metal stripes directly to the substrate with proper screws and washers at a maximum distance of 25 cm between fasteners. The PU joint sealant should be squeezed behind the metal stripe for sealing the potential water penetration behind the membrane. Weld the membrane directly to the KÖSTER TPO Metal Composite Sheets covering at least 6 cm of the metal area.

Attention: Regardless of the chosen installation method, the upper mechanical fastening must be placed at least 15 cm above the maximum water level of the tank. For the tank bottom area, no fastening method is required since the weight of the water holds the membrane in place on the tank bed.

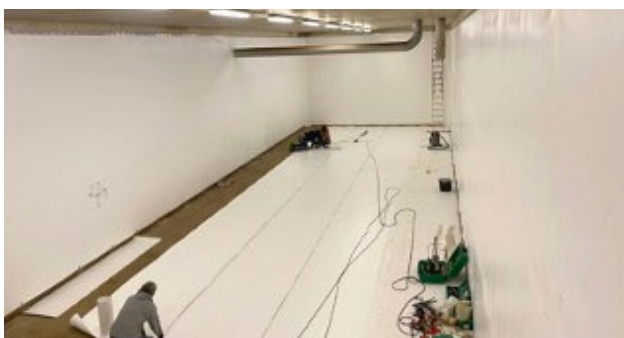

6.2 Seam welding



6.2.1 Welding

Every membrane has markings printed onto it to ease the positioning and orientation of the membrane during application. KÖSTER TPO Aqua membranes can be welded within a wide temperature window between +350 °C to +700 °C. This will depend on the environment parameters. Always do test welding before initiating the application. No chamfering of overlap seams to prevent capillary action is necessary.

When manually welding the membranes, the top layer is first spot welded. The hot air pistol is held in one hand and with the other, the membrane is pressed down and affixed. This creates an air pocket, which traps hot air during final welding maintaining a constant and correct air temperature. After the initial spot welding, the hot air pistol is uniformly pulled through the overlap. A silicone roller is used to press the membranes evenly togeth-

er. Do not press the membranes together too firmly. A slight bead of TPO material exiting the weld serves as optical quality control. The bead should have a diameter of approximately 1 mm. During manual welding make sure that the silicone roller is held parallel to the seam edge and a uniform pressure is applied. Avoid too much material exiting the seam.

When installing on horizontal larger areas, an automatic welding machine is recommended. These machines combine spot and final seam welding into one work step, and the advancement drive speed can be regulated.

To ensure a flawless installation, all corners (such as at the membrane ends) are rounded off with scissors. This step applies to both the lower and upper membrane. It is not necessary to taper the membrane edge.

6.2.2 Overlaps and joints

Overlaps

The general overlap for the KÖSTER TPO Aqua membranes is at least 5 cm if the membranes are installed vertically and they hang loose without intermediate fasteners on the walls.

Membranes that are mechanically fastened require an overlap of at least 11 cm to allow for proper welding beyond the fasteners.

The welding width for loose-laid membranes on horizontal areas must be at least 5 cm.

Use of mechanical fasteners	Minimum required overlapping
Yes	11 cm
No	5 cm

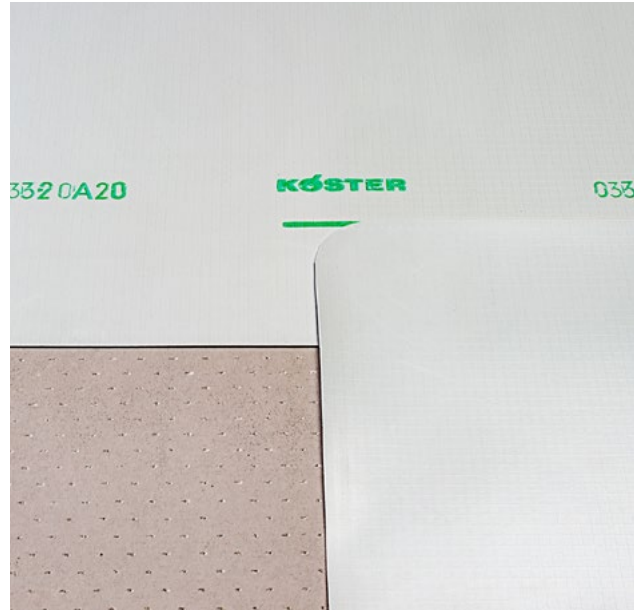

Cross joints

Avoid cross joints whenever possible. This can be achieved by staggering joints or by welding on a cover strip. If a cross joint is unavoidable, it is welded over with a TPO patch ($\varnothing > 20$ cm) to divide the cross joint into four areas.



Butted membrane ends

Head butts are installed exactly like the connection of the membranes in the longitudinal direction. Any corners (e.g. at the end of the membrane) are rounded off with scissors to ensure that the membranes are correctly welded. This step applies to both the lower and the upper layer. The overlap is at least 5 cm.

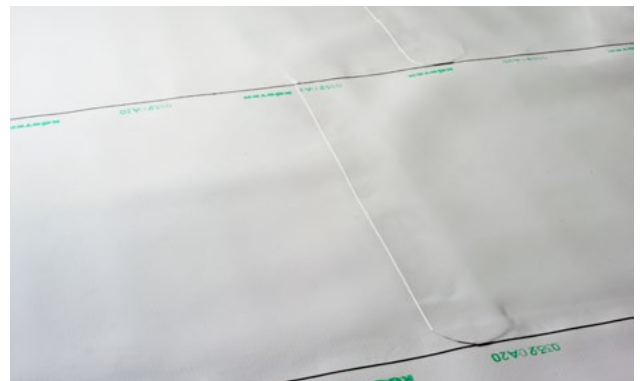

6.3 Vertical and horizontal connections

6.3.1 Vertical connections

Vertical connections are detailed areas where usually two vertical structures (e.g. wall-wall-joint) meet. This vertical detail is waterproofed by extending the KÖSTER TPO Aqua membrane from one wall, at least 25 cm to the adjacent wall. This membrane is then mechanically fastened every 40 - 50 cm for walls up to 5.0 m and every 20 - 25 cm for walls over 5.0 m.

The membrane on the adjacent wall is mechanically fastened only at the top and is then welded over the extension, ensuring an overlap of at least 11 cm to allow for proper welding beyond the fasteners.

Alternatively, the KÖSTER TPO Aqua membranes can be finished at the vertical connection and the membrane ends are covered with at least a 20 cm wide strip to allow welding of a minimum of 5 cm on each side.

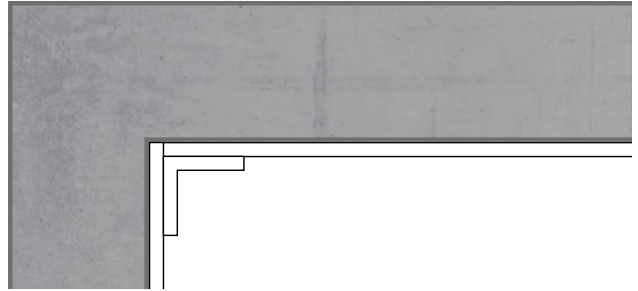
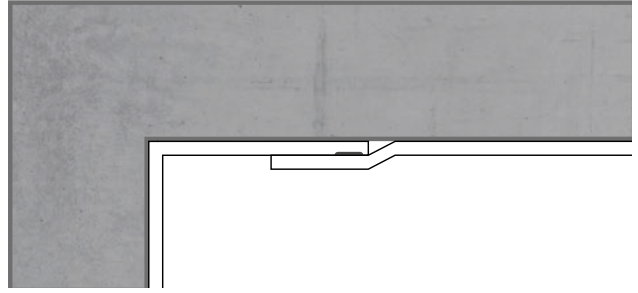

6.3.2 Horizontal connections

Horizontal connections are detailed areas where vertical and horizontal structures (e.g. wall-floor joints) meet. To facilitate welding, the KÖSTER TPO Aqua membranes from the walls should be at least 20 cm longer than the height of the tank and rest loosely on the floor. The horizontal membranes can then be welded on the floor using the automatic welding machine.

6.4 Pipe and other penetrations

6.4.1 Rounded pipe penetrations

If the use of prefabricated pipe flashing is not possible, pipe penetrations can be waterproofed with a 50 x 50 cm flange and a cuff. A hole is cut in the flange at least 4 cm smaller than the pipe diameter. The membrane is preheated and then the flange is pulled over the pipe. The cuff is then welded onto the pipe, at least 2 cm onto the flange. The waterproofing must be carried up at least 15 cm along with the penetration.

The cuff end is secured with a stainless steel hose clamp band or suitable sealant.



6.4.2 Fixed metallic flanges

Fixed flanges can be used for forming a watertight connection between the KÖSTER TPO Aqua membranes and various penetrations. The base of the flange must be securely fixed and sealed into or onto the concrete surface, (never to the screed only). The waterproofing is installed between the base flange (fixed to the concrete) and the clamping flange (loose flange) ensuring that all sealing gaskets are included in the correct order. When installing the waterproofing, the holes required for the threaded flange bolts must be punched out in advance, also no weld seams may be pressed into the flange.

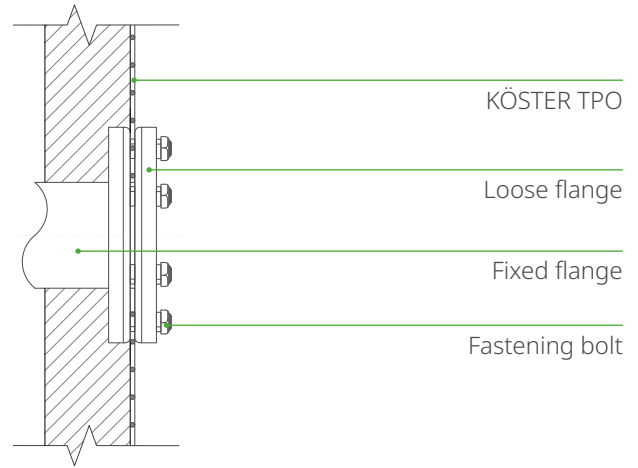

6.5 Quality control

The Installer should be trained in the welding and processing of thermoplastic membranes.

On-site welding tests must be carried out every day to determine the correct welding parameters. The settings must be checked and readjusted if necessary when conditions change.

The seam is to be checked with a peel and shear test on an approx. 5 cm wide weld seam sample. The seam should not be separable. The leading edge of the seam must also be checked! **Important: The test sample must be completely cooled down before the test!**

If the welding samples are of poor quality, the welding parameters such as temperature, speed, pressure, and air volume must be adjusted.

If waterproofing membranes are welded later, for example at connections, welding tests must be carried out with the already installed KÖSTER TPO Aqua membranes. If the welding results are not satisfactory, it may be necessary to clean the installed membranes in the weld area or to roughen them mechanically.

The seam inspection of the installed membrane should happen >24 hours after welding and is carried out with a Weld Seam Tester. Ideally, the temperature of the membranes should be approximate +20 °C.

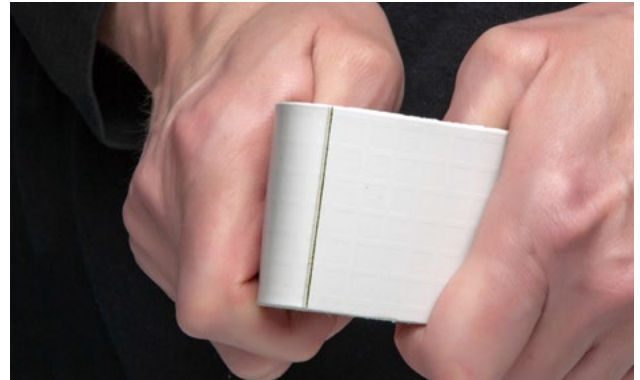

7 Transport and storage

The KÖSTER TPO Aqua waterproofing membranes are frost-proof and generally insensitive to the weather and may be stored outdoors on construction sites even in adverse weather conditions (down to -10 °C). However, it is recommended not to remove any transport packaging such as shrink hoods or stretch films as a protective layer.

The storage and transport of the rolls should always be done standing on a pallet. Lying storage and transport leads to deformation of the rolls and makes the laying and welding of the membranes difficult. Do not stack pallets.

It must be ensured that the goods are not contaminated or damaged during storage. For this purpose, opened pallets should be covered with foil. When installing the membranes in winter, the rolls should be stored in heated or closed rooms.



8 General notes

8.1 Material and system considerations

- After complete installation, wait for 24h before filling the structure with water to allow the welding to be completely cooled down.
- KÖSTER TPO Aqua membranes resist the attack of most common chemicals, making this membrane also usable in water treatment tanks, basins, and other structures. (For specific chemicals and concentrations, always contact our technical department for clarification).
- KÖSTER TPO Aqua membranes are exclusive to be used in UV-protected water tanks and reservoirs.

8.2 Important considerations

- This method statement is intended for use as a general guideline for the installation of the referred system and must be adapted to suit the local conditions, standards, and specifications, as well as special requirements.
- Testing the suitability of the material and equipment for the intended use is strongly recommended before commencing work.

8.3 Limitations

- Special conditions may require alterations to these recommendations; therefore, a warranty can only be given for the quality of the products but not for the correct usage or the workmanship of the materials.

9 Certifications

Drinking water test according to the German W270-Guideline.

10 Appendix

 0761 15	KÖSTER BAUCHEMIE AG Dieselstraße 1-10, 26607 Aurich KÖSTER TPO 1.5 Aqua EN 13967 0761-CPR-0423 Homogenous waterproofing membrane made from flexible Polyolefine TPO/FPO (PE)
Length according to DIN EN 1848-2	20 m
Width according to DIN EN 1848-2	1.50 m
Effective thickness according to DIN EN 1849-2	1.5 mm
Designation according to SPEC 20.000-202 Color Visible Defects according to DIN EN 1850-2 Straightness according to DIN EN 1848-2 Mass per unit area according to DIN EN 1849-2 Water tightness according to DIN EN 1928 (Method B) Resistance to shock loads according to DIN EN 12691 Exposure to liquid chemicals, including water according to DIN EN 1847 Reaction to Fire according to DIN EN 13501-1 Water vapor diffusion resistance according to DIN EN 1931 Tensile characteristics according to DIN EN 12311-2 Tensile strength Elongation at break Resistance to static loading according to DIN EN 12730 Tear continuation resistance according to DIN EN 12310-2 Exposure to bitumen according to DIN EN 1548 Shear resistance of the overlap according to DIN EN 12317-2 Tear resistance (nail shank) according to DIN EN 12310-1	DIN EN 13967:2012 Moisture barrier type T BA-FPO/TPO-BV-1.5 white free from visible defects passed 1500 g/m ² 400 kPa/72h dicht ≥ 800 mm (Method A) watertight (Verf. A) Class E $\mu = 76.500$ ≥ 8 N/mm ² (Method B) ≥ 700 % (Method B) ≥ 20 kg ≥ 400 N passed Failure beyond the overlap ≥ 400 N

KÖSTER TPO Aqua is not long-time UV stable. The membrane is stable during installation. Protect the membrane from permanent UV.

11 Legal disclaimer

This method statement reflects general cases with standard parameters. It is not suitable as a step-by-step guide for all and each waterproofing projects as the conditions on site at the moment of the application cannot be foreseen. It is solely the applicator's responsibility to

decide on the actual procedure considering the specific situation on the construction site. In any case, KÖSTER's Terms of business are valid and can be viewed under www.koester.eu 